

*InstaRack™ Server*  
*Logistics & Accessories*





<b>1</b>	<b>InstaRack™ Server Logistic Data</b> .....	<b>3</b>
<b>2</b>	<b>InstaRack™ Server + Accessories EAN Codes</b> .....	<b>4</b>
<b>3</b>	<b>Accessories</b> .....	<b>7</b>

## 1 InstaRack™ Server Logistic Data

InstaRack™ Server Rack Type	Gross Dimensions (height x width x depth in mm – incl. pallet)	Gross Weight
4 x type 1 racks on pallet	2260 x 2270 x 900	500 kg
4 x type 2 racks on pallet	2260 x 2270 x 900	510 kg
4 x type 3 racks on pallet	2260 x 2270 x 900	530 kg
4 x type 4 racks on pallet	2260 x 2270 x 900	700 kg
4 x type 5 racks on pallet	2260 x 2270 x 900	710 kg
4 x type 6 racks on pallet	2260 x 2270 x 900	730 kg
4 x type 7 racks on pallet	2260 x 2270 x 900	460 kg
4 x type 8 racks on pallet	2260 x 2270 x 900	470 kg
4 x type 9 racks on pallet	2260 x 2270 x 900	490 kg
4 x type 10 racks on pallet	2260 x 2270 x 900	660 kg
4 x type 11 racks on pallet	2260 x 2270 x 900	670 kg
4 x type 12 racks on pallet	2260 x 2270 x 900	690 kg







InstaRack™ Server Rack Type Single Carton Without Pallet	Gross Dimensions (height x width x depth in mm – without pallet)	Gross Weight
Type 1 racks	530 x 2230 x 860	119 kg
Type 2 racks	530 x 2230 x 860	122 kg
Type 3 racks	530 x 2230 x 860	127 kg
Type 4 racks	530 x 2230 x 860	169 kg
Type 5 racks	530 x 2230 x 860	172 kg
Type 6 racks	530 x 2230 x 860	177 kg
Type 7 racks	530 x 2230 x 860	109 kg
Type 8 racks	530 x 2230 x 860	112 kg
Type 9 racks	530 x 2230 x 860	117 kg
Type 10 racks	530 x 2230 x 860	159 kg
Type 11 racks	530 x 2230 x 860	162 kg
Type 12 racks	530 x 2230 x 860	167 kg

## 2 InstaRack™ Server + Accessories EAN Codes

EAN Code	Part No.	Description
 0 742832 381741	011500078007	InstaRack Server flat pack 600x2000x1000 mm WxHxD
 0 742832 381758	011500078008	InstaRack Server flat pack 600x2000x1100 mm WxHxD
 0 742832 381567	011500078009	InstaRack Server flat pack 600x2000x1200 mm WxHxD
 0 742832 381574	011500078012	InstaRack Server flat pack 600x2200x1000 mm WxHxD
 0 742832 381581	011500078013	InstaRack Server flat pack 600x2200x1100 mm WxHxD
 0 742832 381598	011500078014	InstaRack Server flat pack 600x2200x1200 mm WxHxD
 0 742832 381604	011500088007	InstaRack Server flat pack 800x2000x1000 mm WxHxD
 0 742832 381611	011500088008	InstaRack Server flat pack 800x2000x1100 mm WxHxD

EAN Code	Part No.	Description
 0 742832 410304	011500088009	InstaRack Server flat pack 800x2000x1200 mm WxHxD
 0 742832 410311	011500088012	InstaRack Server flat pack 800x2200x1000 mm WxHxD
 0 742832 410328	011500088013	InstaRack Server flat pack 800x2200x1100 mm WxHxD
 0 742832 410335	011500088014	InstaRack Server flat pack 800x2200x1200 mm WxHxD
 0 742832 410342	011501078007	InstaRack Server assembled pack 600x2000x1000 mm WxHxD
 0 742832 410359	011501078008	InstaRack Server a ssembled pack 600x2000x1100 mm WxHxD
 0 742832 410366	011501078009	InstaRack Server assembled pack 600x2000x1200 mm WxHxD
 0 742832 410373	011501078012	InstaRack Server assembled pack 600x2200x1000 mm WxHxD

EAN Code	Part No.	Description
 0 742832 410380	011501078013	InstaRack Server assembled pack 600x2200x1100 mm WxHxD
 0 742832 410199	011501078014	InstaRack Server assembled pack 600x2200x1200 mm WxHxD
 0 742832 410205	011501088007	InstaRack Server assembled pack 800x2000x1000 mm WxHxD
 0 742832 410212	011501088008	InstaRack Server assembled pack 800x2000x1100 mm WxHxD
 0 742832 410229	011501088009	InstaRack Server assembled pack 800x2000x1200 mm WxHxD
 0 742832 410236	011501088012	InstaRack Server assembled pack 800x2200x1000 mm WxHxD
 0 742832 410243	011501088013	InstaRack Server assembled pack 800x2200x1100 mm WxHxD
 0 742832 410250	011501088014	InstaRack Server assembled pack 800x2200x1200 mm WxHxD

EAN Code	Part No.	Description
 0 742832 410267	011500358001	InstaRack cable manager 42 HU for 2000 mm height
 0 742832 410274	011500358002	InstaRack cable manager 47 HU for 2200 mm height
 0 742832 410281	011500379001	C-rail in sets; 380 mm length
 0 742832 410298	011500379002	C-rail in sets; 480 mm length
 0 742832 410502	011500379003	C-rail in sets; 580 mm length
 0 742832 410519	011500399001	Bolt clamp in sets; clamping range 12-16 mm
 0 742832 410526	011500399002	Bolt clamp in sets; clamping range 22-28 mm
 0 742832 410540	011500399003	Bolt clamp in sets; clamping range 46-52 mm

EAN Code	Part No.	Description
 0 742832 410557	011500428001	InstaRack air partitioning with 3x1 HU panels, vertical, for 2000 mm height, 800 mm width
 0 742832 410564	011500428002	InstaRack air partitioning with 3x1 HU panels, vertical, for 2200 mm height, 800 mm width
 0 742832 410571	011500528001	InstaRack air partitioning closed for 2000 mm height, 600 mm width
 0 742832 410588	011500528002	InstaRack air partitioning closed for 2000 mm height, 800 mm width
 0 742832 410397	011500528003	InstaRack air partitioning closed for 2200 mm height, 600 mm width
 0 742832 410403	011500528004	InstaRack air partitioning closed for 2200 mm height, 800 mm width
 0 742832 410410	011500438001	InstaRack support bracket for roof cabling 800 mm depth
 0 742832 410427	011500438003	InstaRack support bracket for roof cabling 1000 mm depth

EAN Code	Part No.	Description
 0 742832 410434	011500438004	InstaRack support bracket for roof cabling 1100 mm depth
 0 742832 410441	011500438005	InstaRack support bracket for roof cabling 1200 mm depth
 0 742832 410458	011500268001	InstaRack side-by-side row connector mounted on the inside
 0 742832 410465	011500508001	InstaRack cross-beam with casters 600 mm width
 0 742832 410472	011500508002	InstaRack cross-beam with casters 800 mm width
 0 742832 410489	011500368001	InstaRack air partitioning for cable manager height 2000, width 800
 0 742832 410496	011500368002	InstaRack air partitioning for cable manager 2200 mm height, 800 mm width
 0 742832 381666	011500181001	InstaRack roof mount ventilation unit 468 mm length, 299 mm width, 40 mm height

### 3 Accessories

Part No.	Image	Description	ECAT Long Description
011500358001 011500358002		<b>InstaRack cable manager</b>	<ul style="list-style-type: none"> <li>– Left and right versions (2 cable managers) supplied.</li> <li>– Ideal for orderly guiding patch cables (copper conductors and optical fibers).</li> <li>– Retrofitting possible.</li> <li>– Made for for complete hot/cold partitioning.</li> <li>– Cable fingers easy to mount (clip on).</li> <li>– Cables can be fed through the rear thanks to rubber grommets and slots.</li> <li>– For mount depths of 145 mm and above.</li> </ul> <p><b>Material/surface:</b></p> <ul style="list-style-type: none"> <li>– Cable duct: steel sheet; 2.0 mm. Ordering number end digit .8: powder-coated RAL 7021, black grey, structure.</li> <li>– Cable fingers: polyamide (UL 94 V-0), black.</li> </ul> <p><b>Supply schedule:</b></p> <ul style="list-style-type: none"> <li>– 1 left cable duct.</li> <li>– 1 right cable duct.</li> <li>– 4 rows with cable fingers.</li> <li>– 4 rubber grommets.</li> <li>– Mounting material.</li> </ul> <p><b>How supplied:</b></p> <ul style="list-style-type: none"> <li>– In pairs (cable fingers included loose).</li> <li>– Set of 4 pairs.</li> </ul>

$W_{rack}$	$H_{rack}$	Mount Depth	Model	Part No.	UP
800	2000	145 and above	InstaRack	011500358001	Set of 4 pairs
800	2200	145 and above	InstaRack	011500358002	Set of 4 pairs

011500379001 011500379002 011500379003		<b>C-rail</b>	<ul style="list-style-type: none"> <li>– For securing cables using bolt clamps or cable management strips.</li> <li>– Space-saving installation in the InstaRack.</li> </ul> <p><b>Material/surface:</b></p> <ul style="list-style-type: none"> <li>– Steel sheet 1.5 mm, galvanized.</li> </ul> <p><b>Supply schedule:</b></p> <ul style="list-style-type: none"> <li>– 4 C-rails.</li> <li>– Mounting material.</li> </ul> <p><b>How supplied:</b></p> <ul style="list-style-type: none"> <li>– In sets.</li> <li>– Set of 10 units.</li> </ul> <p><b>Note:</b></p> <p>Please order bolt clamps, cable management strips or threaded plates at the same time.</p>
--	---	---------------	---

L	Rack Type	For Insertion Depth	Part No.	UP
380	InstaRack	544.5	011500379001	Set of 10 units
480	InstaRack	644.5	011500379002	Set of 10 units
580	InstaRack	744.5	011500379003	Set of 10 units

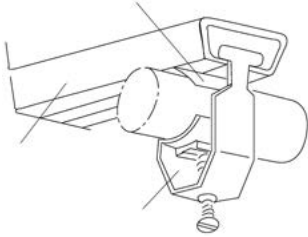
Part No.	Image	Description	ECAT Long Description																
011500399001 011500399002 011500399003	 	<b>Bolt clamp</b>	<ul style="list-style-type: none"> <li>- To release tension and guide individual cables and lines.</li> <li>- Clamping range 12-52 mm.</li> </ul> <p><b>Material:</b> - Steel/plastic.</p> <p><b>Supply schedule:</b> - 25 bolt clamps. - 25 counter troughs.</p> <p><b>How supplied:</b> - In sets. - Set of 10 units.</p>																
			<table border="1"> <thead> <tr> <th>Clamping Range</th> <th>Rack Type</th> <th>Part No.</th> <th>UP</th> </tr> </thead> <tbody> <tr> <td>12-16 mm</td> <td>InstaRack</td> <td>011500399001</td> <td>Set of 10 units</td> </tr> <tr> <td>22-28 mm</td> <td>InstaRack</td> <td>011500399002</td> <td>Set of 10 units</td> </tr> <tr> <td>46-52 mm</td> <td>InstaRack</td> <td>011500399003</td> <td>Set of 10 units</td> </tr> </tbody> </table>	Clamping Range	Rack Type	Part No.	UP	12-16 mm	InstaRack	011500399001	Set of 10 units	22-28 mm	InstaRack	011500399002	Set of 10 units	46-52 mm	InstaRack	011500399003	Set of 10 units
Clamping Range	Rack Type	Part No.	UP																
12-16 mm	InstaRack	011500399001	Set of 10 units																
22-28 mm	InstaRack	011500399002	Set of 10 units																
46-52 mm	InstaRack	011500399003	Set of 10 units																

011500428001 011500428002		<b>InstaRack air partitioning</b>	<ul style="list-style-type: none"> <li>- Quick and easy retrofitting of hot/cold area separation in the InstaRack.</li> <li>- Panels on sides each have two slots for cable feed-through.</li> <li>- 3x 1 HU slots, covered with panels.</li> <li>- Screwed on the sides of the 19" profiles.</li> <li>- Sealing with lateral parts or with same plane in the cabinet placed side-by-side using foam elements; depth can thus be slightly adjusted.</li> </ul> <p><b>Material/surface:</b> - Steel sheet. - Diagonal struts: Powder-coated RAL 7021 black grey, structure.</p> <p><b>Supply schedule:</b> - 2 lateral panels. - 1 panel on base. - 1 foam material on base. - 2 vertical foam materials. - Mounting material.</p> <p><b>How supplied:</b> - In sets. - Set of 4 units.</p>																		
			<table border="1"> <thead> <tr> <th>W</th> <th>H</th> <th>Version</th> <th>Rack Type</th> <th>Part No.</th> <th>UP</th> </tr> </thead> <tbody> <tr> <td>800</td> <td>2000</td> <td>3x 1 HU slot</td> <td>InstaRack</td> <td>011500428001</td> <td>Set of 4 units</td> </tr> <tr> <td>800</td> <td>2200</td> <td>3x 1 HU slot</td> <td>InstaRack</td> <td>011500428002</td> <td>Set of 4 units</td> </tr> </tbody> </table>	W	H	Version	Rack Type	Part No.	UP	800	2000	3x 1 HU slot	InstaRack	011500428001	Set of 4 units	800	2200	3x 1 HU slot	InstaRack	011500428002	Set of 4 units
W	H	Version	Rack Type	Part No.	UP																
800	2000	3x 1 HU slot	InstaRack	011500428001	Set of 4 units																
800	2200	3x 1 HU slot	InstaRack	011500428002	Set of 4 units																



Part No.	Image	Description	ECAT Long Description
011500528001 011500528002 011500528003 011500528004		<b>Closed InstaRack air partitioning</b>	<ul style="list-style-type: none"> <li>– Quick and easy retrofitting of hot/cold area separation in the InstaRack.</li> <li>– Closed lateral panels.</li> <li>– Screwed on the sides of the 19" profiles.</li> <li>– Sealed with lateral parts or with same plane in the cabinet placed side-by-side using foam elements; depth can thus be slightly adjusted.</li> </ul>

**Material/surface:**

- Steel sheet.
- Diagonal struts: Powder-coated RAL 7021 black grey, structure.

**Supply schedule:**

- 2 lateral panels (B800 only).
- 2 vertical foam materials.
- 1 panel on base (for B800 only).
- 1 foam material on base.
- Mounting material.

**How supplied:**

- In sets.
- Set of 4 units.

W	H	Version	Rack Type	Part No.	UP
600	2000	Closed	InstaRack	011500528001	Set of 4 units
800	2000	Closed	InstaRack	011500528002	Set of 4 units
600	2200	Closed	InstaRack	011500528003	Set of 4 units
800	2200	Closed	InstaRack	011500528004	Set of 4 units

011500438001  
011500438003  
011500438004  
011500438005

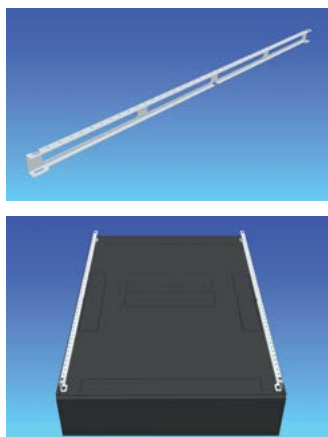

**InstaRack base support for roof cabling**

- Quick and easy to mount.
- Compatible with InstaRack.
- With screw holes for fixing angular brackets, transition and end parts.

**Material/surface:**

- Steel sheet 2.0 mm.
- Ordering number end digit .8: powder-coated, RAL 7021, black grey.

**Supply schedule:**

- 2 base supports.
- Mounting material.

**How supplied:**

- In sets.
- Set of 10 units.

H	D	Rack Type	Part No.	UP
44	800	InstaRack	011500438001	Set of 10 units
44	1000	InstaRack	011500438003	Set of 10 units
44	1100	InstaRack	011500438004	Set of 10 units
44	1200	InstaRack	011500438005	Set of 10 units

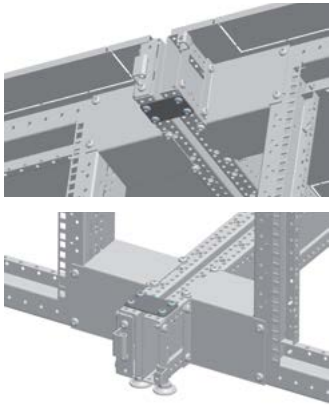
Part No.	Image	Description	ECAT Long Description
011500268001		<b>InstaRack side-by-side row connector</b>	<p>– For a mechanical and stable connection between InstaRack rows.</p> <p><b>Material/surface:</b> – Steel sheet 2 mm, galvanized.</p> <p><b>Installation positions:</b> – 1. On the base of the upper depth structure – 2. On the top of the lower depth structure</p> <p><b>Supply schedule:</b> – 4 side-by-side row connectors. – Mounting material.</p> <p><b>How supplied:</b> – In sets. – Set of 10 units.</p> <p><b>Note:</b> Suitable only for cabinets without partition walls.</p>

Rack Type	Part No.	UP
InstaRack	011500268001	Set of 10 units

011500508001 011500508002		<b>InstaRack cross-beam with casters</b>	<p>– On wheels: also includes two caster receptors with casters and integrated cable insertion.</p> <p><b>Material/surface:</b> – Steel sheet. – Powder-coated, structure RAL 7021.</p> <p><b>Supply schedule:</b> – 1 set of cross-beam with casters. – Mounting material.</p> <p><b>How supplied:</b> – In sets. – Set of 4 units.</p>
------------------------------	---	--	--

W	Rack Type	Part No.	UP
600	InstaRack	011500508001	Set of 4 units
800	InstaRack	011500508002	Set of 4 units

Part No.	Image	Description	ECAT Long Description
011500368001 011500368002		<b>InstaRack air partitioning for cable manager</b>	<ul style="list-style-type: none"> <li>– Compatible with InstaRack.</li> <li>– Separates the hot/cold areas in the cabinet.</li> <li>– Avoids hot spots (air recirculation).</li> </ul> <p><b>Material/surface:</b></p> <ul style="list-style-type: none"> <li>– Panel: steel sheet 1.0 mm. Ordering number end digit .8: powder-coated, RAL 7021, black grey, structure.</li> <li>– Filling foam: polyurethane ether foam (UL94 HF-1).</li> </ul> <p><b>Supply schedule:</b></p> <ul style="list-style-type: none"> <li>– 1 panel on base.</li> <li>– 6 covers for cable feed-through.</li> <li>– 2 foam materials, vertical.</li> <li>– Mounting material.</li> </ul> <p><b>How supplied:</b></p> <ul style="list-style-type: none"> <li>– In sets.</li> <li>– Set of 4 units.</li> </ul>

W	HU	Rack Type	Part No.	UP
800	42	InstaRack	011500368001	Set of 4 units
800	47	InstaRack	011500368002	Set of 4 units

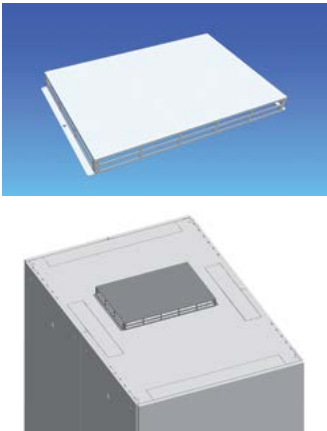
011500181001		<b>InstaRack roof mount ventilation unit</b>	<ul style="list-style-type: none"> <li>– Compatible with InstaRack.</li> <li>– Covering for CoolBlast mounting.</li> </ul> <p><b>Material/surface:</b></p> <ul style="list-style-type: none"> <li>– Base plate, covers: steel sheet 1.0 mm. Ordering number end digit .1: powder-coated, RAL 7035, light grey, structure.</li> </ul> <p><b>Supply schedule:</b></p> <ul style="list-style-type: none"> <li>– 1 roof mount ventilation unit.</li> <li>– Mounting material.</li> </ul> <p><b>How supplied:</b></p> <ul style="list-style-type: none"> <li>– In sets.</li> </ul>
--------------	---	--	---

L	W	H	Rack Type	Part No.	UP
468	299	40	InstaRack	011500181001	Set of 1 unit

## Ensuring The High Availability Of Mission-Critical Data And Applications.

### About Emerson Network Power

Emerson Network Power, a business of Emerson (NYSE:EMR), delivers software, hardware, and services that maximize availability, capacity, and efficiency for data centers, health care, and industrial facilities.

A trusted industry leader in smart infrastructure technologies, Emerson Network Power provides innovative data center infrastructure management solutions that bridge the gap between IT and facility management and deliver efficiency and uncompromised availability regardless of capacity demands. Our solutions are supported globally by local Emerson Network Power service technicians.

Learn more about Emerson Network Power products and services at [www.EmersonNetworkPower.eu](http://www.EmersonNetworkPower.eu).

While every precaution has been taken to ensure accuracy and completeness in this literature, Emerson assumes no responsibility for content, and disclaims all liability for damages resulting from use of this information or for any errors or omissions. Technical data are subject to change without notice.

MKA4L0UKIRSDT Rev.1-11/2014

[EmersonNetworkPower.eu](http://EmersonNetworkPower.eu)

### Locations

#### Emerson Network Power

Global Headquarters  
1050 Dearborn Drive  
P.O. Box 29186  
Columbus, OH 43229, USA  
T +1 614 8880246

#### Emerson Network Power Europe Middle East And Africa

Mariakirchener Strasse 38  
94424 Arnstorf  
Germany  
T +49 8723 27 0  
F +49 8723 27 154  
[knuerr@emerson.com](mailto:knuerr@emerson.com)

#### Emerson Network Power United Kingdom

George Curl Way  
Southampton  
SO18 2RY, UK  
T +44 (0)23 8061 0311  
F +44(0)23 8061 0852

Globe Park  
Fourth Avenue  
Marlow Bucks, SL7 1YG  
Tel: +44 1628 403200  
Fax: +44 1628 403203  
[UK.Enquiries@Emerson.com](mailto:UK.Enquiries@Emerson.com)

Follow us on Social Media:



Emerson, Consider it Solved, Emerson Network Power and the Emerson Network Power logo are trademarks or service marks of Emerson Electric Co. or its affiliated companies. ©2014 Emerson Electric Co. All rights reserved.

EMERSON. CONSIDER IT SOLVED.™